



RCAR Bumper Test

Issue 2.3

July 2023

EDIT 07/2023:

Adjustment of vehicle ride height added to “4.9”

Documentation of vehicle reference height added to “6.2.2” and “6.3.2”

EDIT 02/2020:

Barrier and backstop drawings modified to reflect 300 mm overall height of assembly

Optional barrier position 455 mm discarded in “6.2.1” for rear Bumper Test and “6.3.1” for rear Corner Test

EDIT 02/2018:

Source of supply updated in “Appendix 1 - 3.0 ENERGY ABSORBER”

EDIT 07/2017:

“Vehicle Underbody Measurement” added to “4.0 VEHICLE SET-UP CONDITION”

INDEX**1.0 INTRODUCTION****2.0 SCOPE****3.0 DEFINITIONS****4.0 VEHICLE SET-UP CONDITION****5.0 GEOMETRIC ASSESSMENTS****6.0 DYNAMIC TESTS****7.0 IMPLEMENTATION****APPENDIX 1: Bumper barrier description and sample drawings**

Figures:

- (1) Bumper Barrier (§1.0)
- (2) Qualifying Bumper Beam Height (§5.1.2)
- (3) Bumper Beam Measuring Positions (§5.1.3)
- (4) Bumper Beam with Pedestrian Protection Elements (§5.1.5)
- (5) Relevant Vertical Bumper Engagement (§5.1.7)
- (6) Measuring Bumper Width – Top View A (§5.2.2)
- (7) Measuring Bumper Width – Top View B (§5.2.2)
- (8) Measuring Bumper Width – Front View (§5.2.2)
- (9) Qualifying Bumper Beam Width (§5.2.2)
- (10) Bumper Width Measurement with an outboard Flange – Top View (§5.2.5)
- (11) Example of bolt on extension (§5.2.5)
- (12) Measuring bolt on extensions (§5.2.5)
- (13) 15 Percent Overlap Based on Vehicle Width at Front Axle Measured at Wheel Wells (§6.3.2)

1.0 INTRODUCTION

This document describes the RCAR bumper test procedures that assess bumper performance.

The RCAR Bumper Test encourages vehicle manufacturers to produce effective bumper systems that feature tall energy absorbing beams and crash boxes that are fitted at common heights and can effectively protect the vehicle in low speed crashes. The bumper systems should also have wide beams that protect the corners of the vehicle in low speed crashes.

In the opinion of RCAR, good vehicle bumper beams should:

- be fitted to both the front and rear of vehicles
- be replaceable without cutting or welding
- incorporate a beam height exceeding 100 mm
- be positioned to fully engage with the front and rear bumper barriers
- be torsion-resistant to carry eccentric loads without twisting
- absorb energy and restrict damage to the bumper system only
- be attached to the body via energy absorbing structures that are inexpensive to repair or replace
- be stable during impacts to prevent underride and override
- prevent damage to structural, welded or bonded and other expensive parts
- extend laterally to protect vehicle corners

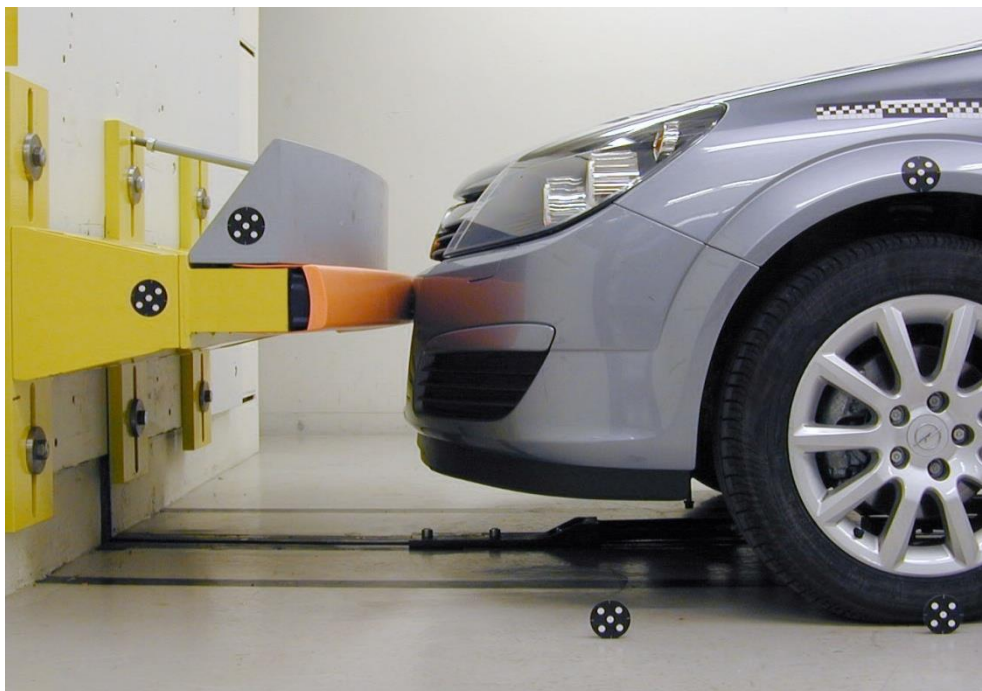

Figure 1: Bumper Barrier

2.0 SCOPE

Improving passenger car damageability and repairability has been an important RCAR topic since the Council was established in 1972. In order to prevent unnecessary damage to the structure of passenger cars in low speed crashes, a 15 km/h, 40 % overlap test was implemented in the 1980s and revised again in 2006 (the impact angle was changed from 0° to 10° and the rear impact moving barrier weight was increased from 1000 to 1400kg). This test is referred to as the RCAR Structural Test.

Car manufacturers design their vehicles to perform well in this RCAR structural test but some have fitted vehicles with countermeasures that do not exhibit good crash behaviour in real world crashes. In some cases, manufacturers have eliminated the bumper beam and replaced them with localized countermeasures, such as crush cans, to manage the test. Such sub-optimised designs are in most cases not robust and often lead to expensive damage in car-to-car crashes.

Insurance claims data indicate that rear bumpers are often underridden by a striking vehicle due to bumper system instability or vertical dive of vehicles during braking. In these cases it is desirable to have bumper systems that have sufficient vertical overlap to maintain engagement. To this end, bumpers should ideally be mounted at slightly different heights front and rear but have sufficient height to maintain engagement over a wide range of circumstances. However, insurance data also show that rear bumpers are overridden when struck by high ride-height vehicles (SUVs, pickup trucks). Vehicle damageability would be improved in both these situations with taller front and rear bumper beams.

Real world claims data also show a significant number of crashes in which damage is limited to the vehicle corners. Vehicle bumpers should prevent or limit much of the damage sustained in these minor crashes. However, many vehicles do not have bumper reinforcement beams that extend laterally much beyond the frame rails, leaving expensive vehicle components such as headlamps and fenders (wings) unprotected.

An international RCAR working group has developed test procedures to assess how well a vehicle's bumper system protects the vehicle from damage in low speed impacts. Damage in these tests closely replicates the damage patterns observed in real world low speed crashes and addresses three components of bumper performance:

1. Geometry – vehicle bumpers need to be positioned at common heights from the ground and extend laterally to the corners in order to properly engage other vehicles in low speed crashes.
2. Stability – vehicle bumpers need to be tall and wide enough to remain engaged with the bumpers of other vehicles despite vehicle motion due to loading, braking, etc.
3. Energy-absorption – vehicle bumpers should absorb low speed crash energy without damage to other parts of the vehicle.



The new bumper tests incorporate a rigid bumper-shaped barrier fitted with an energy-absorbing material and cover. The barrier, shown in Figure 1, is 100 mm tall and is mounted to an immovable surface and impacted by test vehicles. The limited height of the barrier encourages uniform vehicle bumper heights from the ground. The deformable energy-absorbing element encourages designs that remain stable when impacting deformable material, like another vehicle's bumper system. It also features a solid rear "backstop" that can replicate real world damage severities where underride occurs. Lastly, it encourages designs that absorb crash energy while limiting intrusion into the vehicle.

3.0 DEFINITIONS

Barrier Ground Clearance:

The distance from the track surface to the lower surface of the bumper barrier.

Bumper Backstop:

The rigid steel contoured plate on top of the barrier described in Appendix 1, §2.2.

Bumper Barrier:

The rigid steel contoured barrier described in Appendix 1, §2.0 and 4.0.

Bumper Barrier Assembly:

The bumper barrier with the backstop attached to the top and the energy absorbing element attached to the face.

Bumper Beam:

Structural cross member under the bumper fascia protecting the front or rear of the vehicle. (Note: The beam does not include foam, cover support or pedestrian protection devices, see 5.1.5).

Bumper Beam Height:

Maximum vertical distance measured between the highest and lowest points on the bumper beam profile.

Bumper Cover:

The plastic cosmetic fascia that covers the vehicle bumper beam.

Energy Absorber:

The energy absorbing element attached to the face of the bumper barrier described in Appendix 1, §3.0 and 4.0.

Energy Absorber Cover:

The cover to the energy absorbing element listed above is intended to form an even contact surface. This can be an integral part of the EA element or a separate part.

Qualifying Bumper Beam Height:

Aggregate vertical distance, determined by the measuring procedure described in §5.1.2 to 5.1.6.

Qualifying Bumper Beam Ratio:

The ratio of bumper beam width to the vehicle width at the corresponding axle (§5.2.2)

Relevant Vertical Bumper Engagement:

Vertical overlap of the bumper barrier and the vehicle's qualifying bumper beam height (§5.1.7).

Under/override:

Vertical movement that is greater than the relevant engagement during the deceleration phase.

**Vehicle Nominal Ride Height:**

The nominal ground clearance between the highest point of the outer wheel arch vertically above the wheel center and ground as defined by the manufacturer in the model specifications (or other body reference points designated by the manufacturer).

Vehicle Reference Height:

Ground clearance of the wheel arches (or reference points) of the individual test vehicle under static test conditions.

4.0 VEHICLE SET-UP CONDITION

The vehicle to be tested should be at the vehicle manufacturer's nominal curb weight plus the weight of fuel and additional test devices as stated.

The vehicle should be at the nominal ride height (± 10 mm) as specified by the vehicle manufacturer. For vehicles equipped with height-adjustable chassis, the system setting for normal driving shall be chosen (default, nominal, standard, etc.), and the final ride height as well as the setting of the respective controls to achieve this ride height must be documented. If available, the nominal ride height shall be documented in the same context of the report.

If appropriate, the test house may decide to test vehicles in the "as delivered" condition. The tires should be inflated to the manufacturer's recommended pressure for single occupant loading and low speed conditions. The fuel tank should be filled to at least 90 percent of capacity with appropriate fuel or an approved substitute. Equivalent weight may also be positioned near the fuel tank.

The test weight includes a 75 ± 5 kg test dummy or equivalent weight on the driver's seat secured with the standard 3-point seat belt. Additional weight of necessary test equipment may be added without removing vehicle parts for compensation.

The equipment shall be placed in a low position (e.g. on the floor) to reduce the influence on the vertical vehicle dynamics (i.e. pitch).

If applicable, measurements including test weight, vehicle reference height in the test condition and the bumper geometry as specified in sections 5.1.2 through 5.1.7 shall be recorded.

To determine vehicle deformation, external panel gap and underbody measurements shall be taken before and after each impact at locations agreed upon by the test facility/manufacturer (see suggested forms in RCAR Low-speed structural crash test protocol).

Any suitable measuring equipment may be utilized, providing the same reference points are used each time and the equipment produces a permanent record of the measured data. Other measurements may be taken with the agreement of the test facility and the manufacturer.

5.0 GEOMETRIC ASSESSMENT

5.1 Full-width

5.1.1 Basic requirements

Some vehicles with a bumper system optimized to the test procedure may engage the barrier in the dynamic bumper test but may not perform well in real world conditions. Bumper beams that have insufficient vertical height will be presumed to fail the test. These include:

- a) bumper systems that do not feature bumper beams as defined above
- b) small bumper beams with insufficient vertical height
- c) bumper beams that do not engage (overlap) the bumper barrier sufficiently.

RCAR has developed a measuring procedure to assess cases b) and c) above. Based on this procedure bumper beams are likely to be insufficient, if the

relevant vertical bumper engagement is < 75 mm (see *figure 5 in §5.1.7*).

Some vehicles may fail to reach this engagement due to their design, but are equipped with tall bumper beams which may perform well in real crashes. Therefore vehicles with qualifying bumper beam heights (see fig. 2 in §5.1.2) of 100 mm or more shall be subject to the dynamic test if the relevant bumper engagement is less than 75 mm and a reasonable test result can be anticipated. The vehicle's bumper system must sufficiently engage with the bumper barrier to be deemed acceptable. Systems that use the backstop for energy management will be regarded as unacceptable.

5.1.2 Measuring the Qualifying Bumper Beam Height

After removing all detachable components (e.g. energy absorbing materials) the bumper beam height shall be measured from a vertical plane contacting the beam up to 10 mm into the profile to get the qualifying bumper beam height. The procedure is shown in Figure 2.

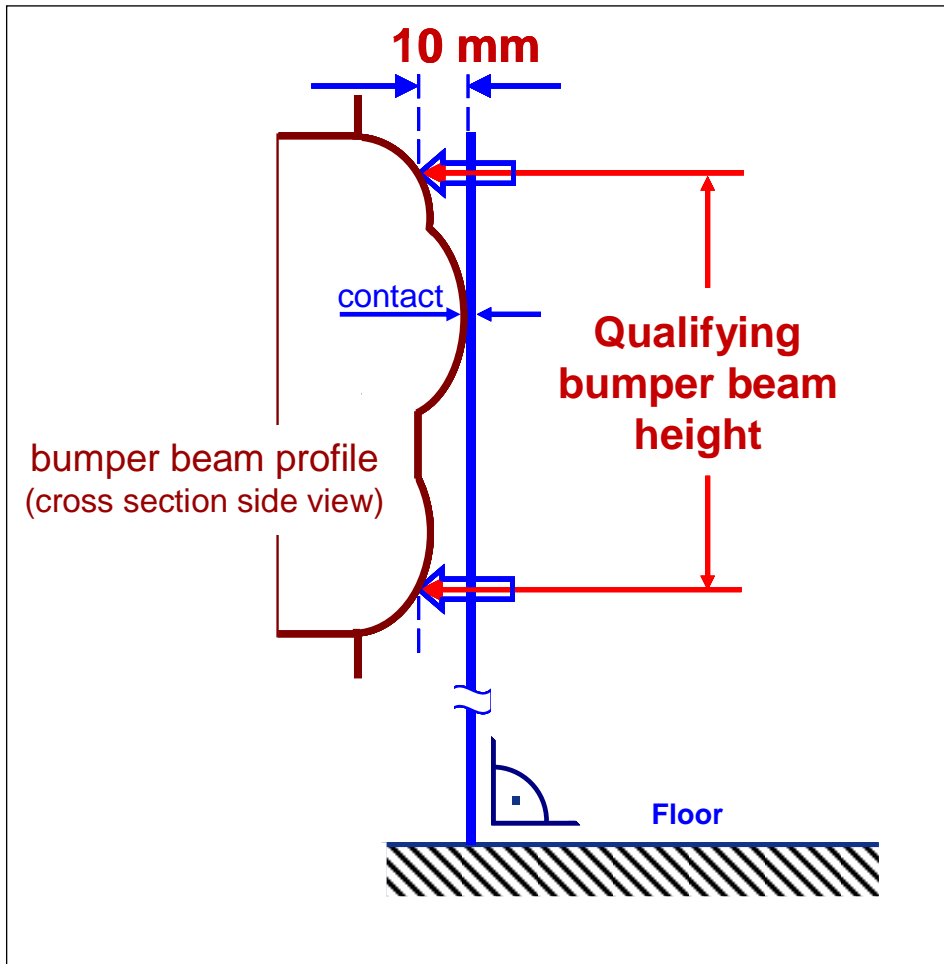

Figure 2: Measuring the Qualifying Bumper Beam Height

5.1.3 Measuring position

The beam is measured at three locations as indicated in Figure 3.

The locations are in the center of the vehicle (C) and at the center of each frame rail (R and L). All three values are measured within a band width of ± 50 mm. The minimum within each band is taken.

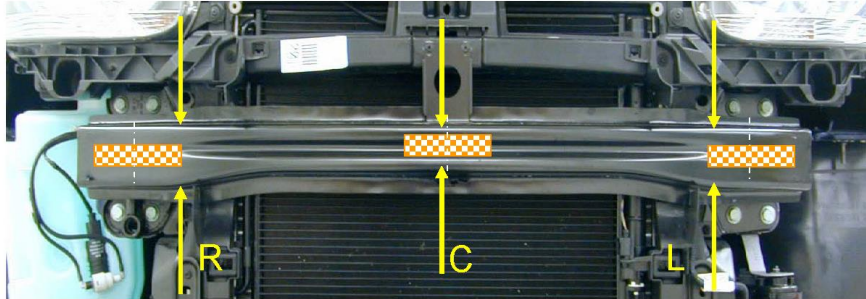
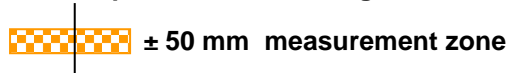

Figure 3: Bumper Beam Measuring Locations



5.1.4 Calculating the Qualifying Bumper Beam Height

Values “R” and “L” are weighted 25% and value “C” is weighted 50%.

$$\text{Qualifying Bumper Beam Height} = (0.25 * (R + L)) + (C * 0.5)$$

Example: R=90 mm, L=90 mm, C= 60 mm

$$\begin{aligned} \text{Qualifying Bumper Beam Height} &= (0.25 * (90 + 90)) + (60 * 0.5) \text{ [mm]} \\ &= 75 \text{ mm} \end{aligned}$$

5.1.5 Pedestrian protection

If non detachable components for pedestrian protection are integral with the bumper beam, only the bumper beam should be measured.

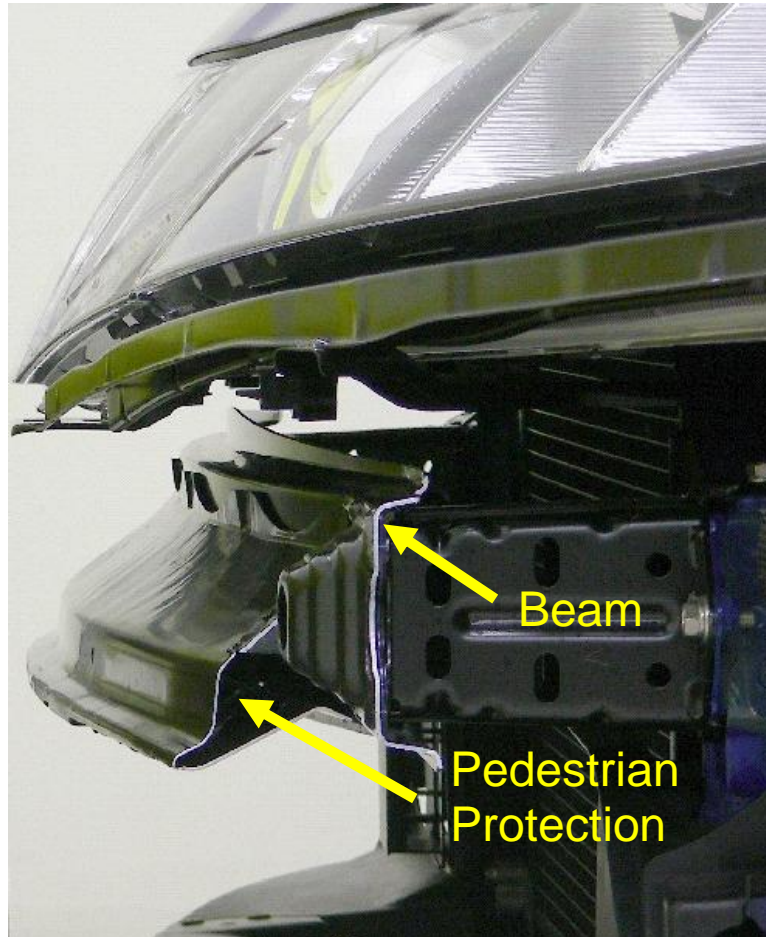

Figure 4: Bumper Beam with Pedestrian Protection Elements

5.1.6 Flanges

Elements of the bumper beam that are not of sufficient strength on the outer edges such as flanges will be disregarded. Instead, the structure behind (within the 10 mm range, as in 5.1.2) is measured. A flange thickness of 5 mm or more may be regarded as “structural”, as well as a flange, or the part of it, which is not higher than the flange material thickness. Special materials (e.g. high strength steel) and/or shapes (e.g. corrugated) and/or supports may be used in the measurement as well, if appropriate.

5.1.7 Relevant Vertical Bumper Engagement

Before measuring the relevant vertical engagement, the vehicle reference height must be verified. The relevant vertical bumper engagement is found by determining the overlap between the qualifying bumper beam height and the bumper barrier (Figure 5). The relevant vertical bumper engagement is measured at each of the locations in §5.1.3 and weighted using the method described in §5.1.4.

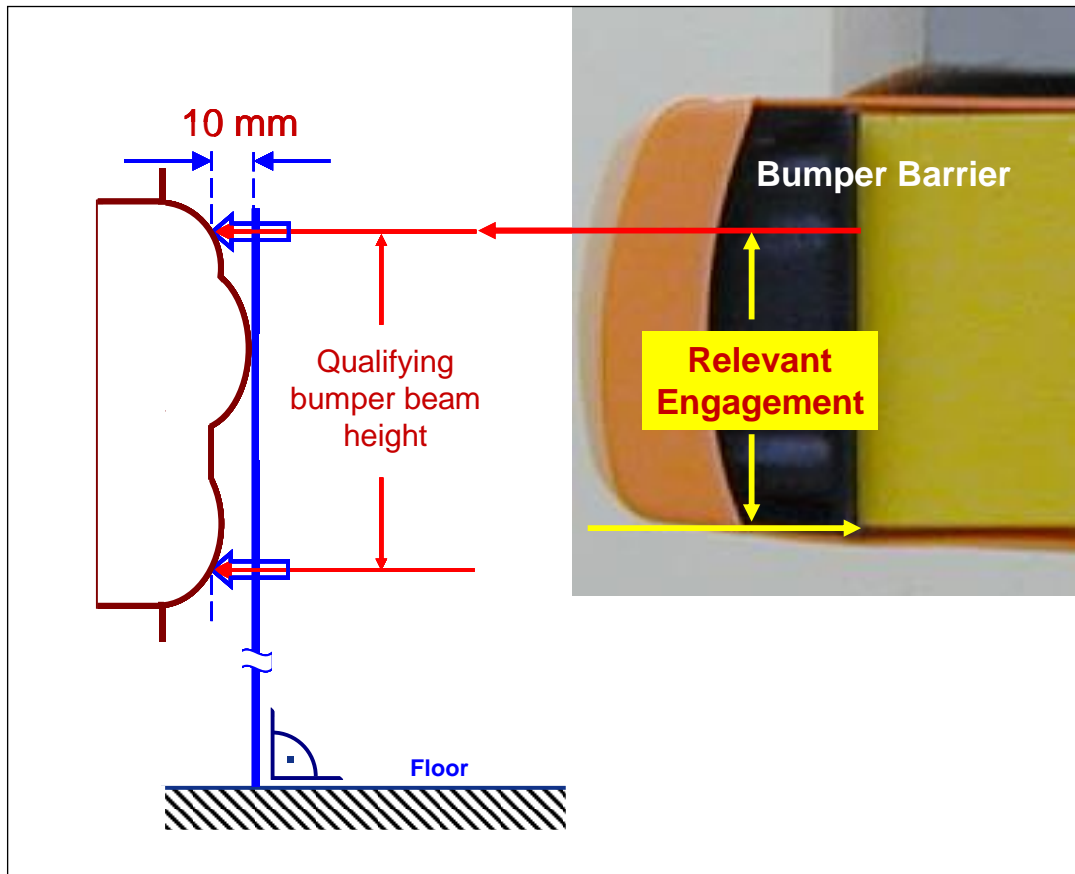

Figure 5: Relevant Bumper Engagement

5.2 Corner

5.2.1 Basic requirements

Vehicles should be equipped with bumper beams that protect the vehicle corners. Vehicles that leave more than 15% of their width unprotected at each corner will be deemed unacceptable.

5.2.2 Measuring the bumper beam width

The bumper beam width shall be measured after removing all detachable components (e.g. energy absorbing materials). The bumper beam width shall be measured from the left most outboard section of the bumper beam to the right most outboard section of the bumper beam (Figures 6 & 7). If the ends of the beam are less than the qualifying bumper beam height for the full-width test (§5.1), they will not be included in the measurement of the bumper beam width (Figure 8).

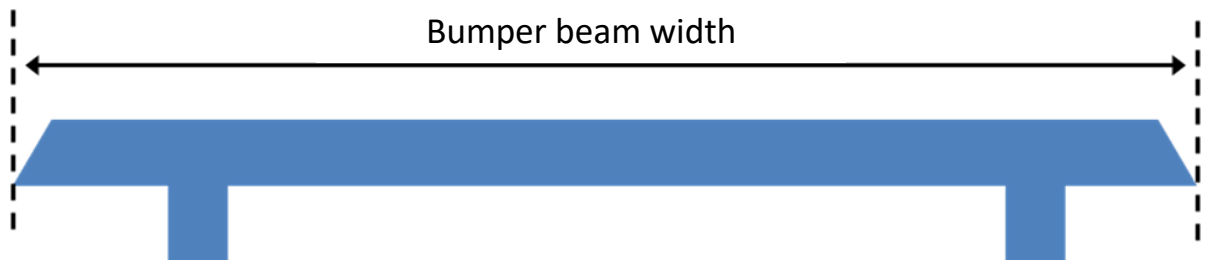

Figure 6. Measuring Bumper Width (flat) - Top View A

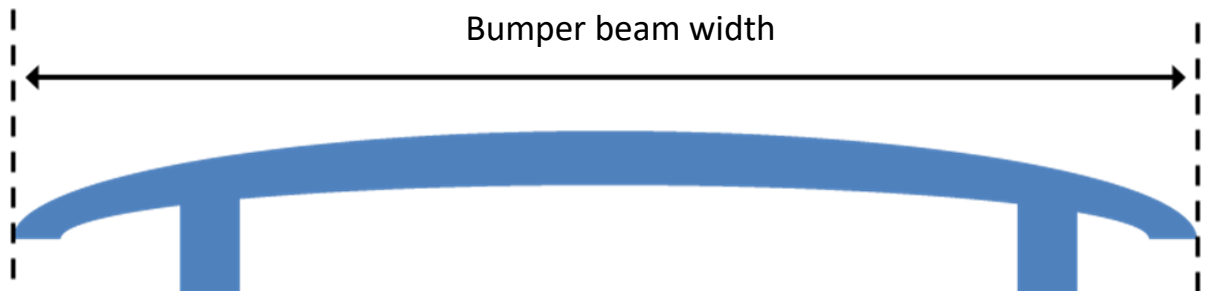

Figure 7. Measuring Bumper Width (curved) - Top View B

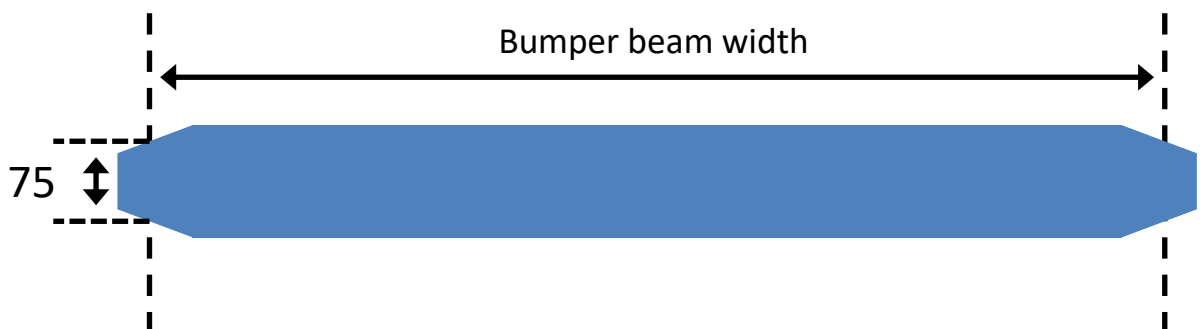

Figure 8. Measuring Bumper Width within 75 mm Vertical Engagement – Front View

5.2.3 Measuring the Qualifying Bumper Beam Ratio

The vehicle width is measured at the wheel wells (including moldings and sheet metal protrusions) at the corresponding axle — front axle for the front bumper and rear axle for the rear bumper. The bumper beam and vehicle width measurements are shown in Figure 9. The qualifying bumper beam width calculation is given below.

$$\text{Qualifying Bumper Beam Ratio} = 100 * \left(\frac{\text{Bumper Beam Width}}{\text{Vehicle Width}} \right)$$

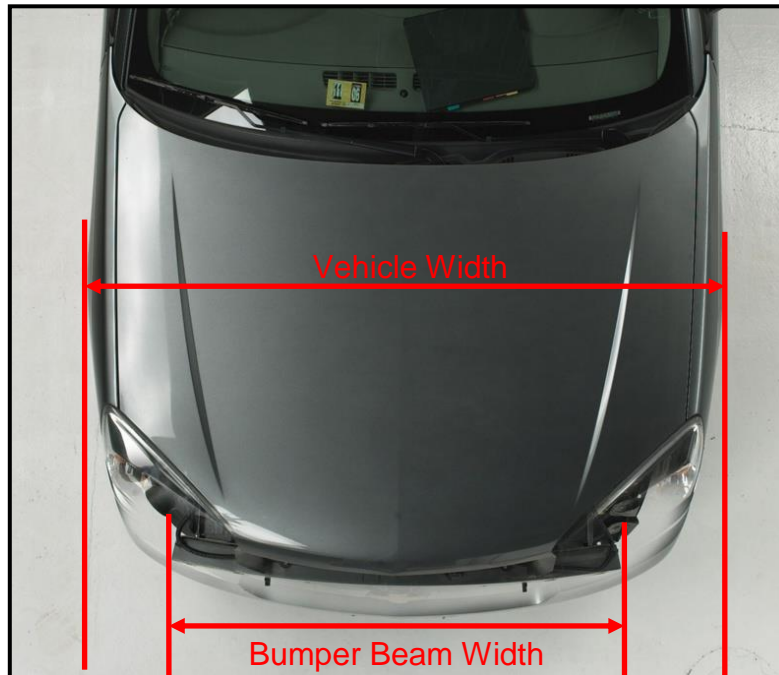

Figure 9: Qualifying Bumper Beam Width

5.2.4 Pedestrian protection

If non detachable components for pedestrian protection are integral with the bumper beam, only the bumper beam should be measured.

5.2.5 Flanges and corner extensions

Elements of the bumper beam that are not of sufficient strength on the outer edges such as flanges will be disregarded. A flange thickness of 5 mm or more may be regarded as “structural” (Figure 10). Extensions that are attached (e.g. bolted, welded, etc.) to the bumper beam may be used in the measurement as well, as long as the extension height is at least the same as the qualifying bumper beam height (§5.2.2). An example of an extension is shown in Figures 11 and 12.

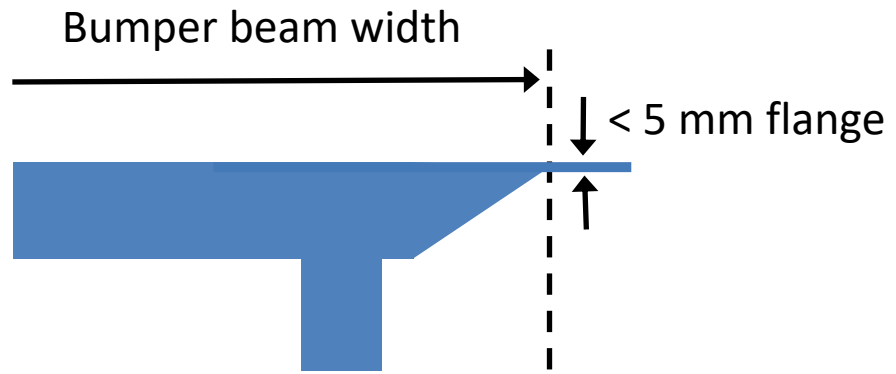

Figure 10. Bumper Width Measurement with an outboard flange - Top View



Figure 11. Example of bolt on extension

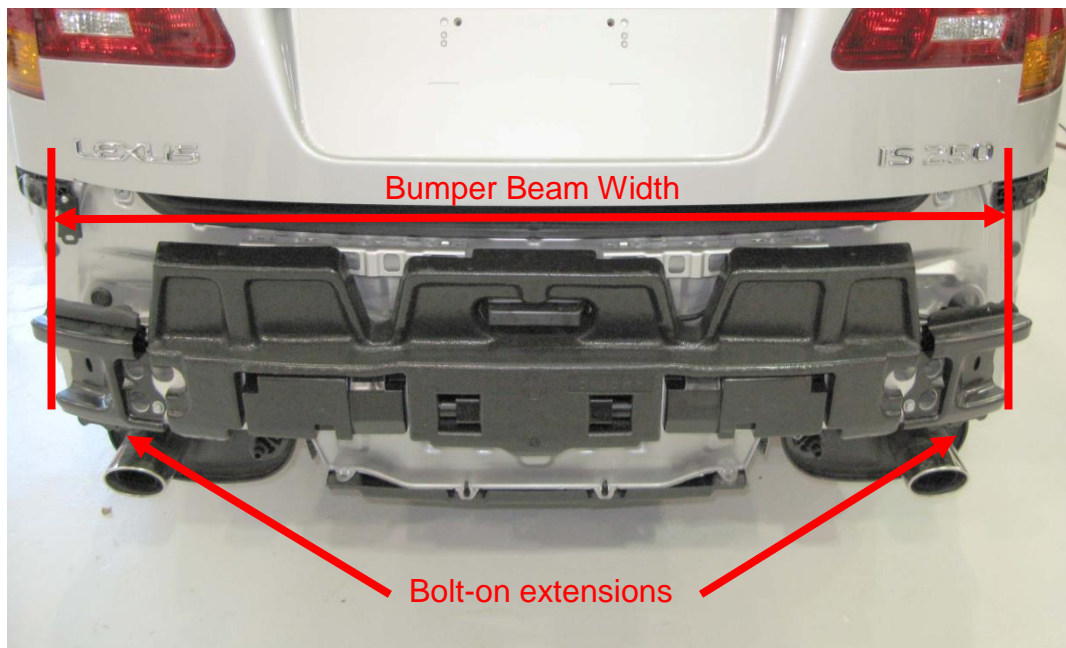

Figure 12. Measuring bolt-on extensions

6.0 DYNAMIC TESTS

6.1 General Test Information

6.1.1 Vehicle Set-up

In addition to the static set-up conditions specified in §4, the vehicle's ignition switch should be turned to the on position (position 2) with all safety equipment (belt pretensioners and airbags) live. If the vehicle is running on its own wheels, the transmission should be in the neutral position with the parking brake fully released.

It is recommended that the air conditioning system be drained and the pressure checked.

6.1.2 Vehicle Movement

Moving barriers show considerable dynamic movement during a crash due to inertial properties, suspension, tires, etc. This movement would degrade the test reproducibility and repeatability. Therefore the bumper barrier tests shall be conducted with the vehicle striking the fixed bumper barrier. Test houses shall ensure drive systems or vehicle speed controls do not influence the test condition. At the moment of impact the vehicle shall be free of relevant exterior or propelling forces (to stabilize the approach some drag may be allowed, e.g. using hand brake).

6.2 Full-width Tests

Insurance claims data indicate that rear bumpers are often overridden by the striking vehicle when vehicles of similar type collide due to the influence of dynamic vertical dive of vehicles during braking. Due to this the front and rear bumper tests are undertaken at differing heights.

Insurance data also show that rear bumpers are overridden when struck by high ride-height vehicles (SUVs, pickup trucks). In markets where such vehicles are common the rear test may be conducted at the higher mounting position to prevent override.

6.2.1 Barrier Position

The barrier ground clearance shall be 455 mm \pm 3 mm for frontal impacts and 405 mm \pm 3 mm for rear impacts.

6.2.2 Vehicle Position

At impact, the centreline of the vehicle shall be aligned with the center of the bumper barrier. Due to the differences in vehicle propulsion systems, individual test houses shall determine what amount of lateral deviation is acceptable. In most cases, maximum lateral deviations of up to \pm 50 mm are permissible.

The vehicle reference height shall be documented in front of the barrier directly before the dynamic test.

When the car dynamically approaches the impact point, the vehicle reference height at the crash condition should be as close as possible to the height measured under the static conditions before the crash (a deviation of not more than ± 10 mm is desirable). If a larger deviation occurs, the test house shall evaluate its influence on the test behavior and its possible relevance for the test result.

6.2.3 Impact Velocity

The impact velocity shall be 10.0 km/h ± 0.5 km/h.

6.3 CORNER TESTS

Real world claims data also show a significant number of crashes in which damage is limited to the vehicle corners. Vehicle bumpers should prevent or limit much of the damage sustained in these minor crashes. However, many vehicles do not have bumper reinforcement beams that extend laterally much beyond the frame rails, leaving expensive vehicle components such as headlamps and fenders (wings) unprotected.

6.3.1 Barrier position

The barrier ground clearance shall be 455 mm ± 3 mm for frontal impacts and 405 mm ± 3 mm for rear impacts.

6.3.2 Vehicle Position

At impact, the vehicle shall overlap the lateral edge of the barrier by 15 percent of the vehicle's width as measured at the wheel wells (including moldings and sheet metal protrusions) at the corresponding axle — front axle for front corner tests (Figure 13) and rear axle for rear corner tests. The maximum lateral deviation is ± 25 mm.

The vehicle reference height shall be documented in front of the barrier directly before the dynamic test.

When the car dynamically approaches the impact point, the vehicle reference height at the crash condition should be as close as possible to the height measured under the static conditions before the crash (a deviation of not more than ± 10 mm is desirable). If a larger deviation occurs, the test house shall evaluate its influence on the test behavior and its possible relevance for the test result.

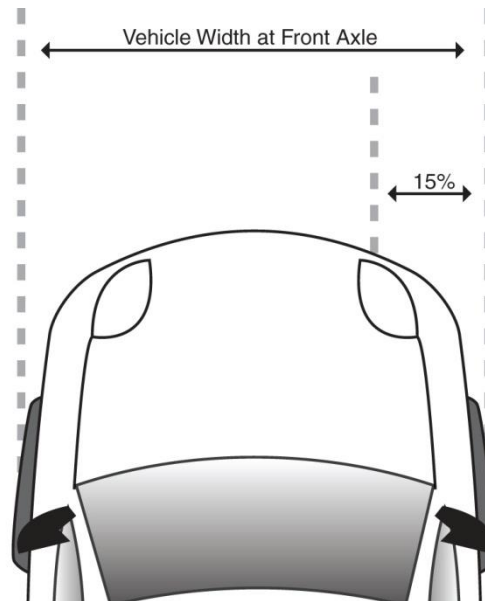

Figure 13. 15 Percent Overlap Based on Vehicle Width at Front Axle Measured at Wheel Wells

6.3.3 Impact Velocity

The impact velocity shall be 5.0 km/h \pm 0.5 km/h.



7.0 IMPLEMENTATION

While this RCAR Bumper Test should encourage vehicle manufacturers to produce effective bumper systems, RCAR members (or the associated test organizations) are free to adopt different parts of the bumper test procedure in their country. They may decide to only use the geometric assessments, only conduct dynamic tests or they may use any combination of the geometric assessments or dynamic test procedures. The organizations may also use the results from the procedures in differing ways for rating or consumer information purposes to suit local market conditions.



Appendix 1

Dimensions and Specifications of the RCAR Bumper Barrier System

INDEX**1.0 INTRODUCTION****2.0 BUMPER BARRIER****3.0 ENERGY ABSORBER****4.0 BUMPER BARRIER ASSEMBLY AND COMPONENTS DRAWINGS**

Figures:

- (1) Steel Bumper Barrier with Backstop (§2.1)
- (2) Bumper Barrier and Backstop with rounded corners (§2.2)
- (3) Energy Absorber without Cover (§3.1)
- (4) Complete Bumper Barrier Assembly (Backstop, Cover, and Energy Absorber) (§3.1)
- (5) Energy Absorber Force Deflection Corridors - Perpendicular Loading (§3.4.1)
- (6) Energy Absorber Force Deflection Corridors - Eccentric Loading (§3.4.2)
- (7) An Example of an Eccentric Load Plate (§3.4.6)
- (8) Bumper Barrier and Energy Absorber, Top View (§4.0)
- (9) Bumper Barrier and Energy Absorber, Section A-A (§4.0)
- (10) Energy Absorber and Bumper Cover (§4.0)
- (11) Steel Barrier Layout without backstop (§4.0)
- (12) Backstop Dimensions (§4.0)
- (13) Main Barrier Dimensions, top view (§4.0)

1.0 INTRODUCTION

This document gives the specifications and dimensions for the bumper barrier and energy absorber test devices used as part of the assessment of damageability in bumper tests.

2.0 STEEL BARRIER

2.1 Design and Dimensions

The bumper barrier (Figure 1) is a rigid construction made of steel with a radius of $3400 \text{ mm} \pm 25 \text{ mm}$ across its full width. It is $1500 \text{ mm} \pm 25 \text{ mm}$ wide with a flat, $100 \text{ mm} \pm 2 \text{ mm}$ tall vertical face. The barrier is at least 230 mm deep at its center (without flanges), 143 mm deep at each end, and should be constructed such that it can be mounted to an unyielding and immovable crash wall at various heights. The steel barrier has a 25.4 mm radius incorporated into each end. (See §4 for drawings).



Figure 1: Steel Bumper Barrier with Backstop

2.2 Backstop

A rigid backstop is fixed on top of the barrier. It is constructed from a steel plate, 190 mm \pm 2 mm tall and at least 8 mm thick, with the same radius and width as the bumper barrier. The backstop is positioned 25 mm \pm 1 mm behind the flat vertical steel bumper barrier face, measured in the bumper barrier center line (Figures 2 and 3). A gap (max. 10 mm) between the backstop and the upper barrier surface shall allow for unimpaired sliding of the energy absorber cover (§3.3). The top of the backstop shall be 200 mm \pm 2 mm from the upper bumper surface, including the gap. The steel backstop also has a 25.4 mm radius incorporated into each end.

The overall height of the barrier and backstop assembly shall be 300 mm \pm 2.



Figure 2: Bumper Barrier and Backstop with rounded corners

3.0 ENERGY ABSORBER

3.1 General

Several different energy absorbers were used in the development of the RCAR bumper system including aluminum honeycomb, aluminum egg-crate, and thermo-plastic materials. The test results using these various energy absorbers were found to be largely independent of the material. Thus, the energy absorber properties for perpendicular loading and specifications in this document encompass the properties of all the absorbers used in the test development process. The energy absorber does not have to be one piece, as long as the dimensions, crush strength, surface hardness and coefficient of friction are within the specified ranges. One current design¹ consists of two components: an energy absorber and a separate cover. If the system consists of more than one piece, the entire assembly shall be used when evaluating the crush strength.



Figure 3: Energy Absorber without Cover

¹ sales and distribution: sales@cellbond.com



Figure 4: Complete Bumper Barrier with Backstop, Cover, and Energy Absorber

3.2 Dimensions

The energy absorber shall be as long as the bumper face, 50 mm deep and is curved along its length to a radius of 3400 mm to allow for mounting on the barrier face. The front face of the absorber has a 150 mm \pm 2 mm top-to-bottom radius, see drawings in §4.0, Figures 9 and 10.

3.3 Mounting

The energy absorber should be firmly affixed to the underlying bumper barrier face without gaps at the interface. In case the cover of the EA element is wrapped around the metal barrier and fastened on the top and bottom plane of the barrier, the cover shall be able to slide rearwards without influencing the deformation of the EA element. For this purpose a gap between the metal barrier and the backstop is needed. One current design of the cover provides slotted holes to allow unrestricted sliding when the cover is fixed by mushroom type plastic fasteners. When screws are used they shall not squeeze the cover material. All fasteners should sit in the far end of the slots to keep the cover in position under slight tension and allow full travel through the slot under impact forces. Other methods of fixing a cover are acceptable as long as they allow for unrestricted sliding. Horizontal forces needed to slide the cover rearwards should not exceed 50 N.

3.4 Material Properties – Crush Strength

3.4.1 Force Deflection Corridors – Perpendicular Loading

When subjected to quasi-static tests set forth in §3.4.3 through §3.4.5, the forces and deflections should fall within the corridors shown in Figure 5.

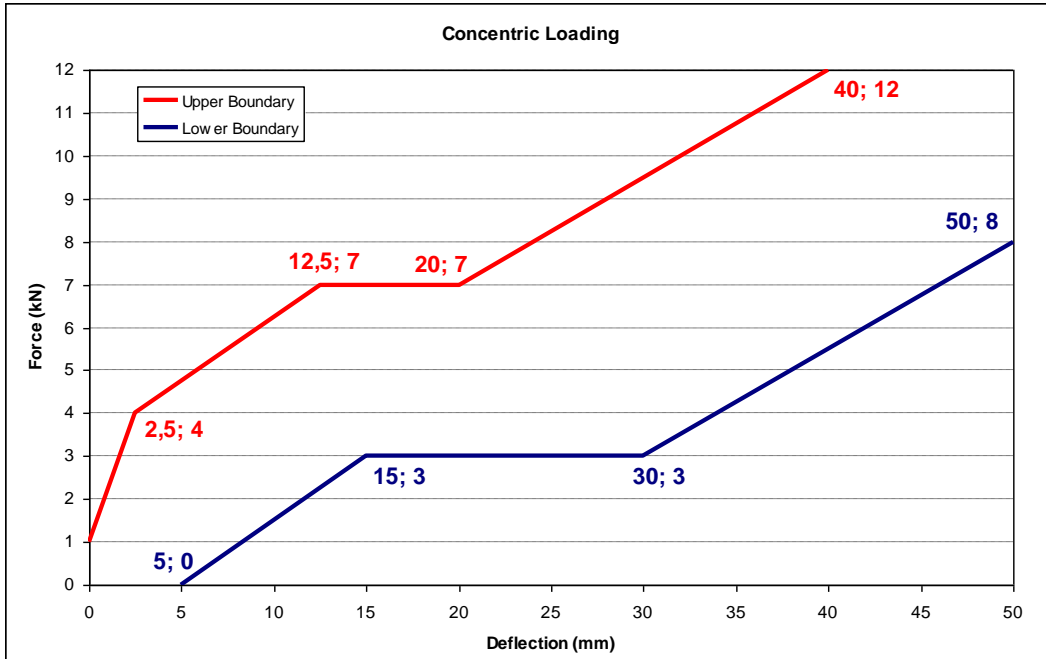

Figure 5: Energy Absorber Force Deflection Corridors - Perpendicular Loading

3.4.2 Force Deflection Corridors – Eccentric Loading

When subjected to quasi-static tests set forth in §3.4.3, §3.4.4, and §3.4.6 the forces and deflections should fall within the corridors shown in Figure 6.

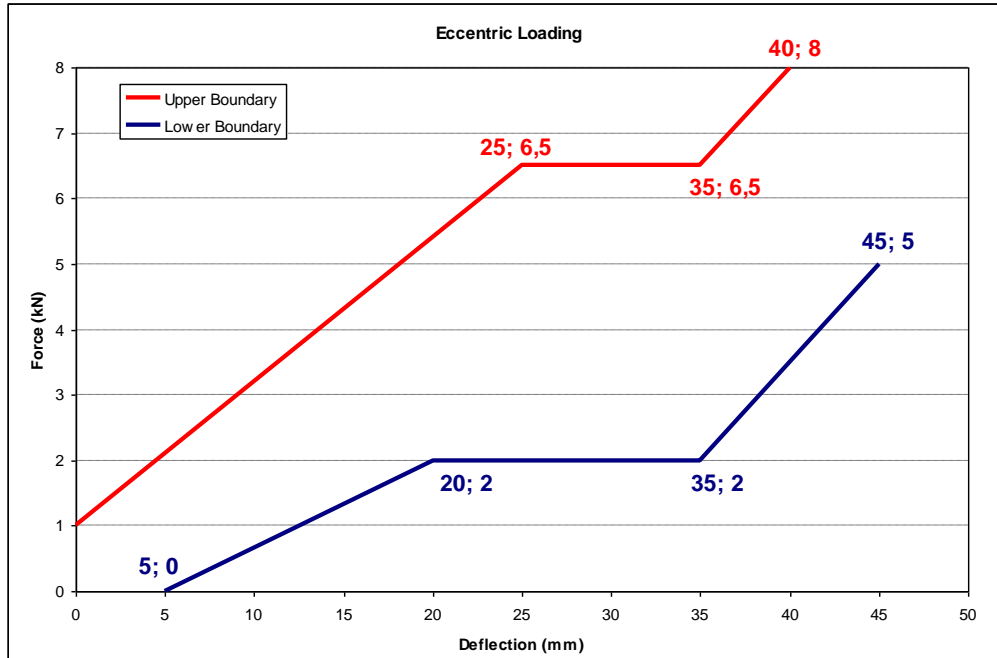

Figure 6: Energy Absorber Force Deflection Corridors - Eccentric Loading

3.4.3 Crush Strength Test Mounting

The crush strength should be evaluated with the absorber mounted to a rigid support in a fashion similar to its attachment to the bumper barrier.

3.4.4 Crush Strength Test Speed

The tests should be run at 450 ± 50 mm/min (e.g. Tinius Olsen Universal Test Machine).

3.4.5 Crush Strength Load Plate – Perpendicular Loading

The load plate should be a rigid rectangular piece of steel 160 mm long and wide enough to cover the entire height of the absorber (i.e. 100 mm).

3.4.6 Crush Strength Load Plate – Eccentric Loading

The load plate should be a rigid rectangular piece of steel 160 mm long and wide enough to cover half of the height of the absorber (i.e. 50 mm). The plate should be able to rotate along the impacting surface. An example load plate is shown in Figure 7.

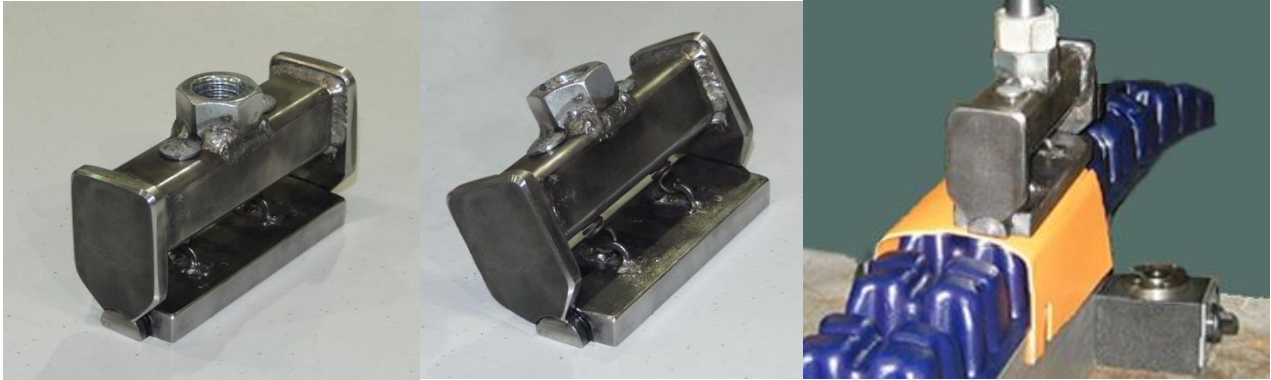

Figure 7: An Example of an Eccentric Load Plate

3.4.7 Material Properties – Impact Surface

The impact surface of the energy absorber should have a hardness value between 30 and 150 Bhn² and have a dynamic coefficient of friction between 0.25 and 0.5.³

² Brinell Hardness Number. The Brinell Hardness Number is obtained using a 3000 kg load and a 10 mm standard ball. The range of 30 to 150 Bhn encompasses materials with hardness values between 25 and 100 Shore D and Rockwell Hardness values of zero to 80 Rb.

³ The dynamic coefficient of friction is obtained against steel.

4.0 BUMPER BARRIER ASSEMBLY DRAWINGS

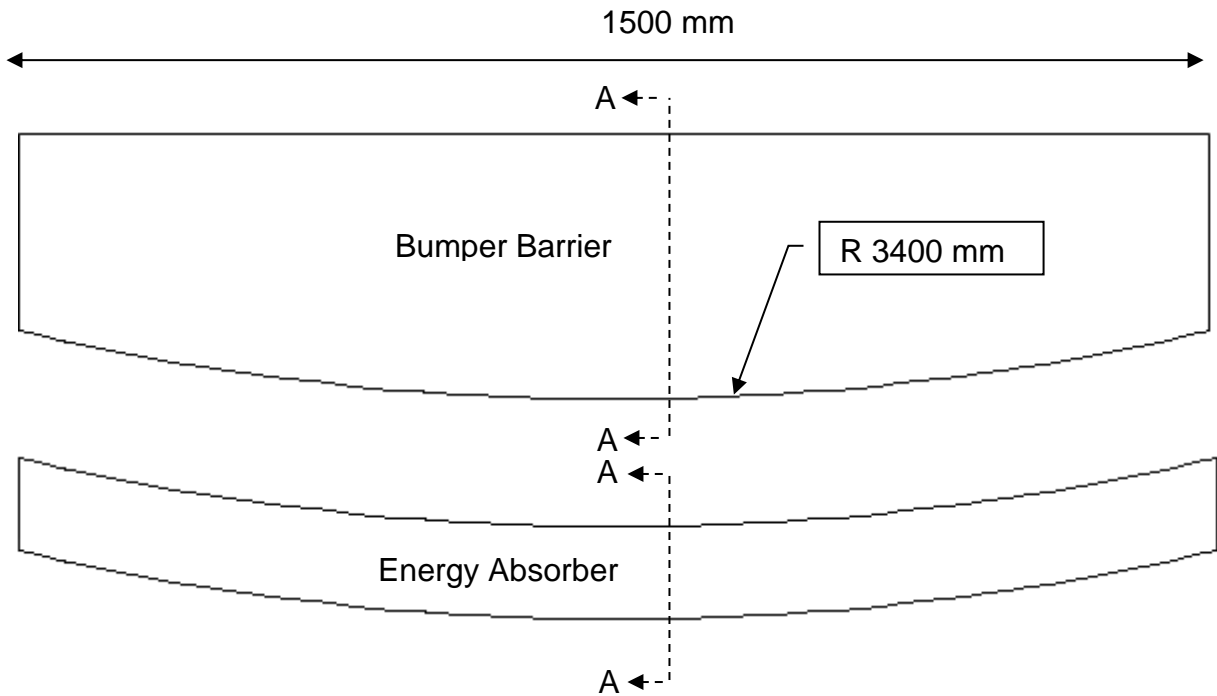

Figure 8: Bumper Barrier and Energy Absorber, Top View

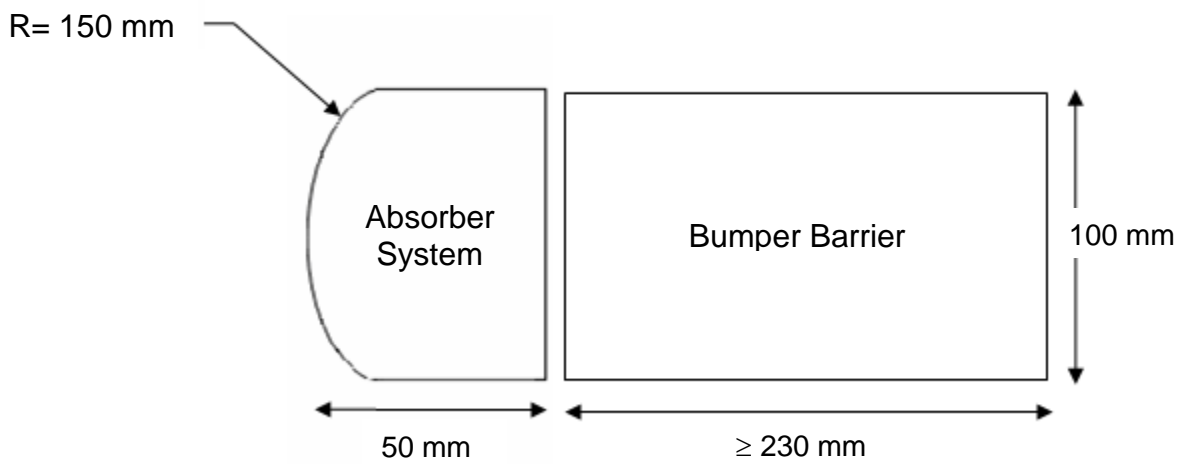

Figure 9: Bumper Barrier and Energy Absorber, Section A-A

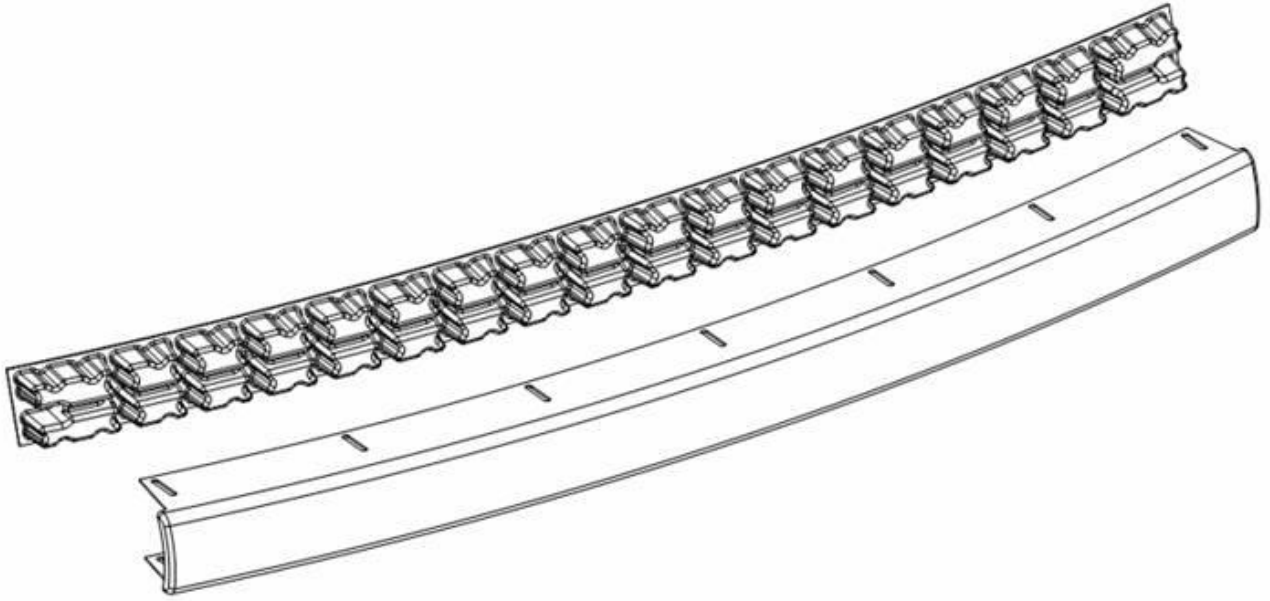

Figure 10: Energy Absorber and Bumper Cover

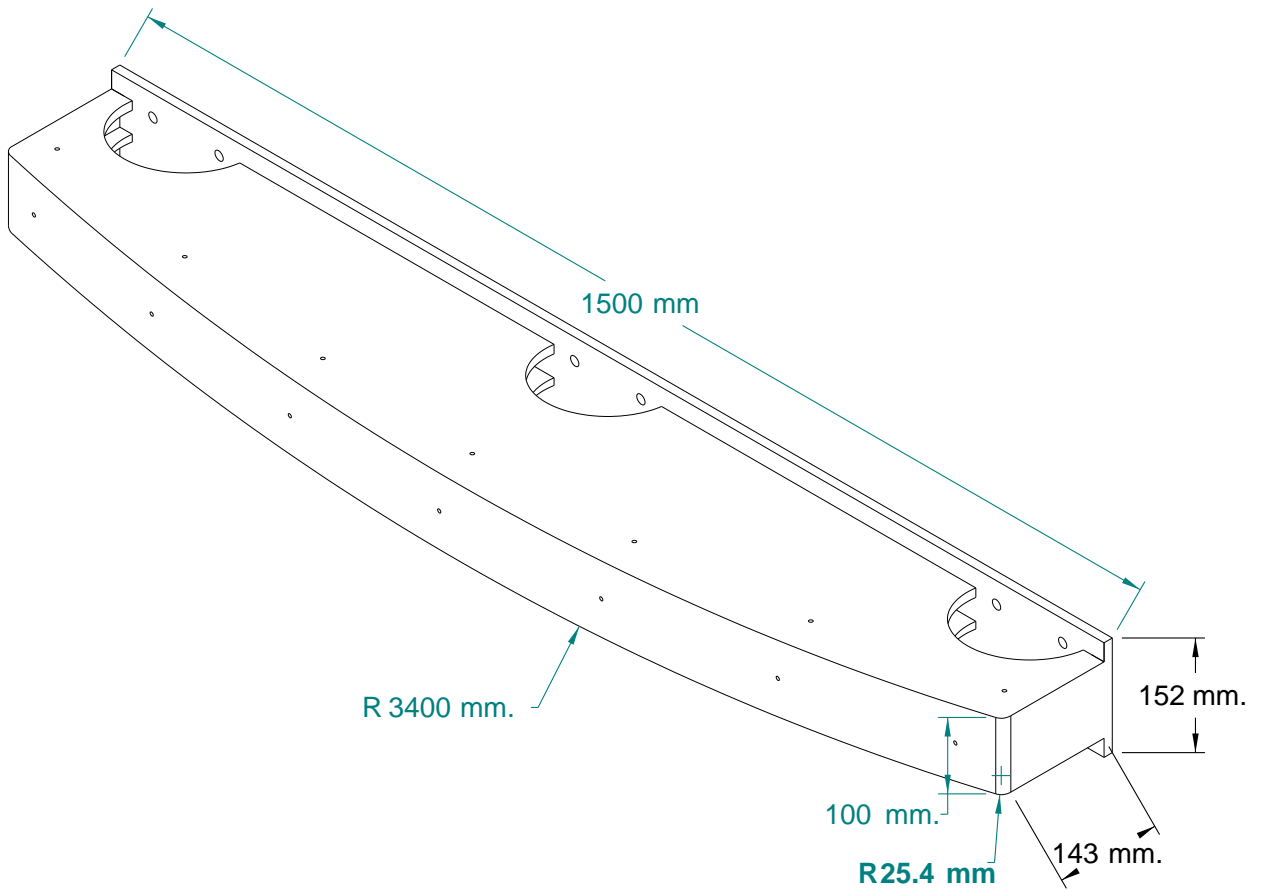

Figure 10: Steel Barrier Layout without backstop

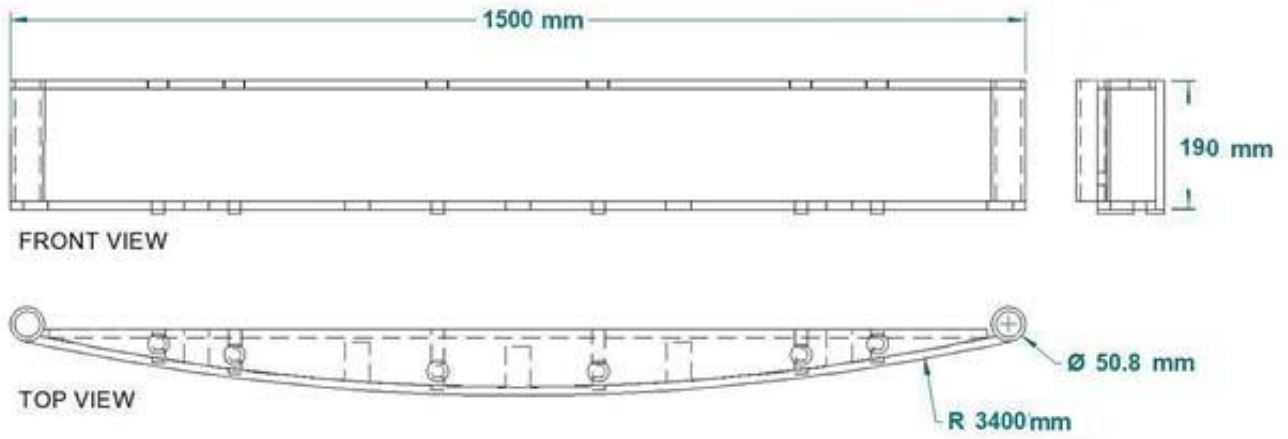

Figure 10: Backstop Dimensions

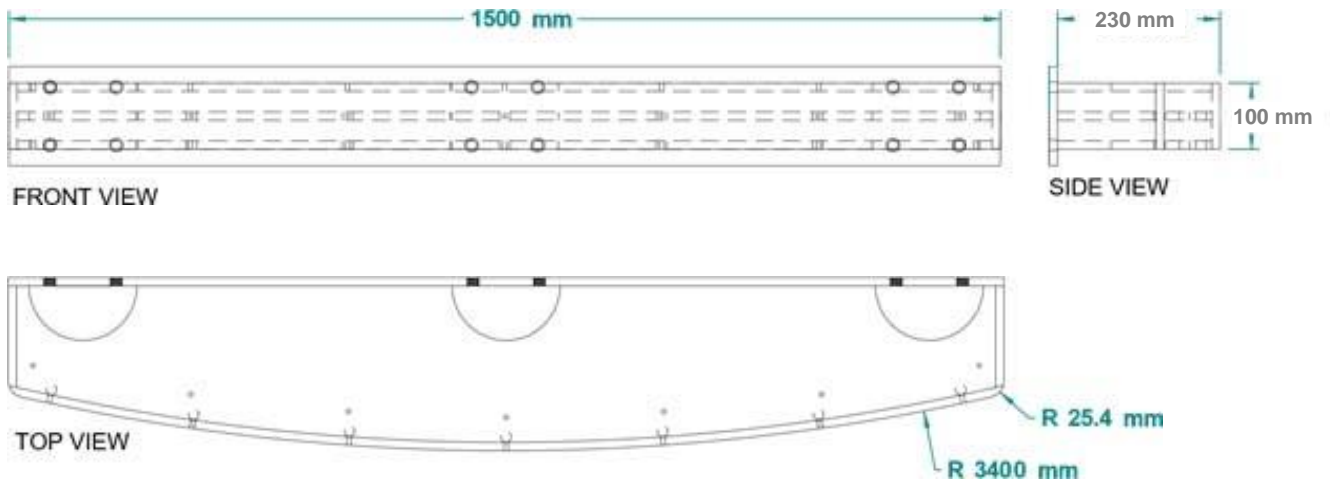

Figure 13: Main Barrier Dimensions, top view